

60" 1080p LED QUICK SETUP GUIDE DX-60D260A13

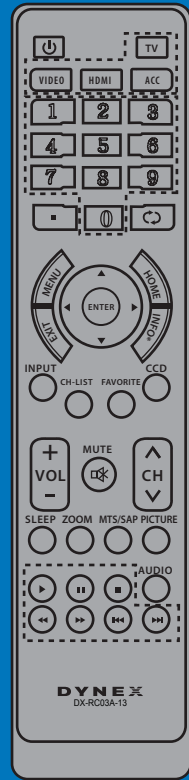

Remote control and 2 AAA batteries

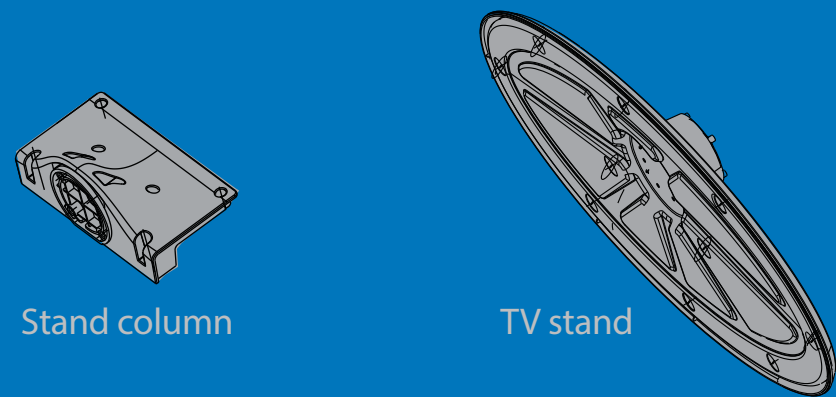
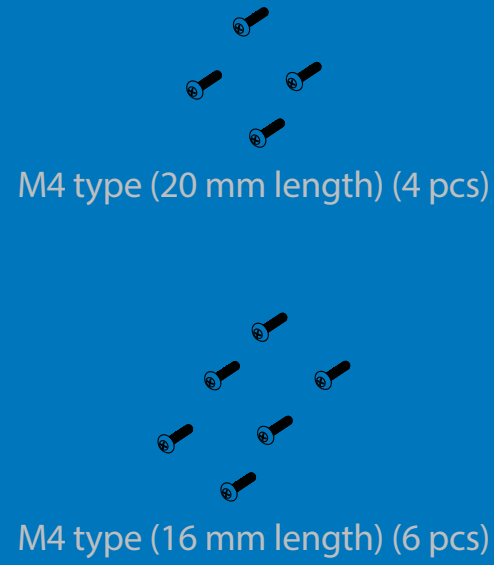

Stand column

TV stand

WE ARE GOING GREEN!

A copy of your *User Guide* is not provided in the box but is available online. Go to www.dynexproducts.com, then click **Support & Service**. Enter your model number in the **Manual, Firmware, Drivers & Product Information**, then click **Search**.



Front features

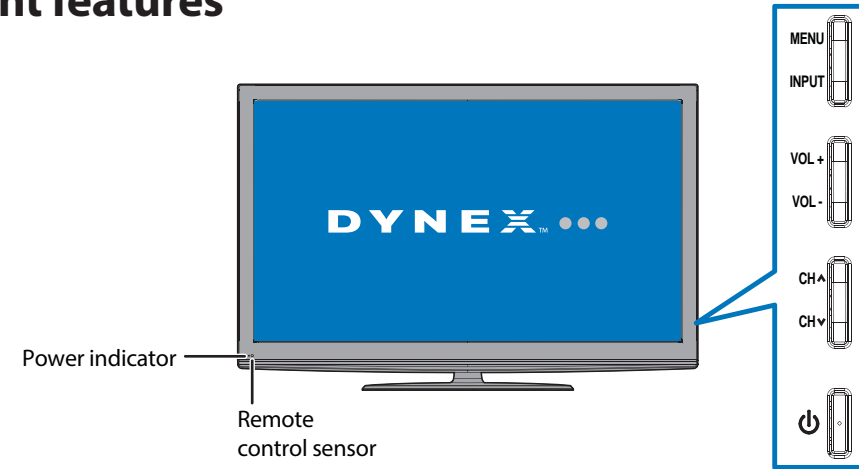

Installing the stand

- Carefully place your TV face-down on a cushioned, clean surface to protect the screen from damages and scratches.
- Attach the stand to the stand column using the four provided M4 screws (20 mm).
- Attach the stand assembly to the TV using the six provided M4 screws (16 mm).

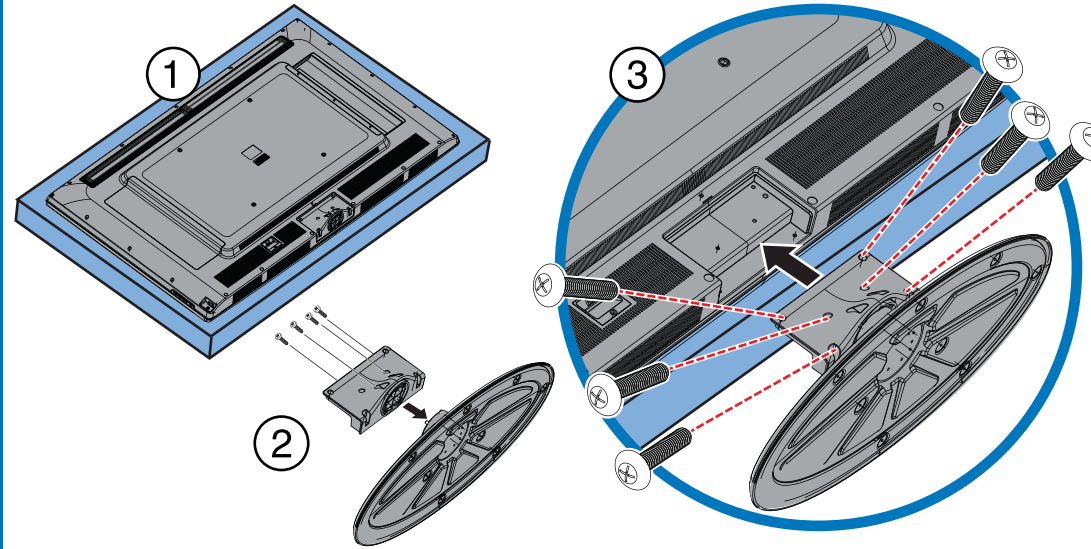

Installing a wall-mount bracket

- Carefully place your TV face-down on a cushioned, clean surface to protect the screen from damages and scratches.
- Attach the wall-mount bracket to your TV using the mounting holes on the back of your TV. See the instructions that came with the wall-mount bracket for information about how to correctly hang your TV.

Warning

This apparatus is intended to be supported by a UL Listed wall mount bracket.

Identifying cables

Your TV has several connection types for connecting devices. For the best video quality, connect a device to the best available connection.

Connection type	Video quality	Cable connector
HDMI video/audio	Best	
OR		
Component video and analog audio	Better	
OR		
Composite video and analog audio	Good	

You can use the HDMI1/DVI jack to connect a DVI device to your TV. You need to attach HDMI-to-DVI adapter to the end of the HDMI cable that connects to the DVI device's jack.

Connecting a DVD or Blu-ray player, cable box, satellite receiver, camcorder, or game console Using an HDMI cable (best)

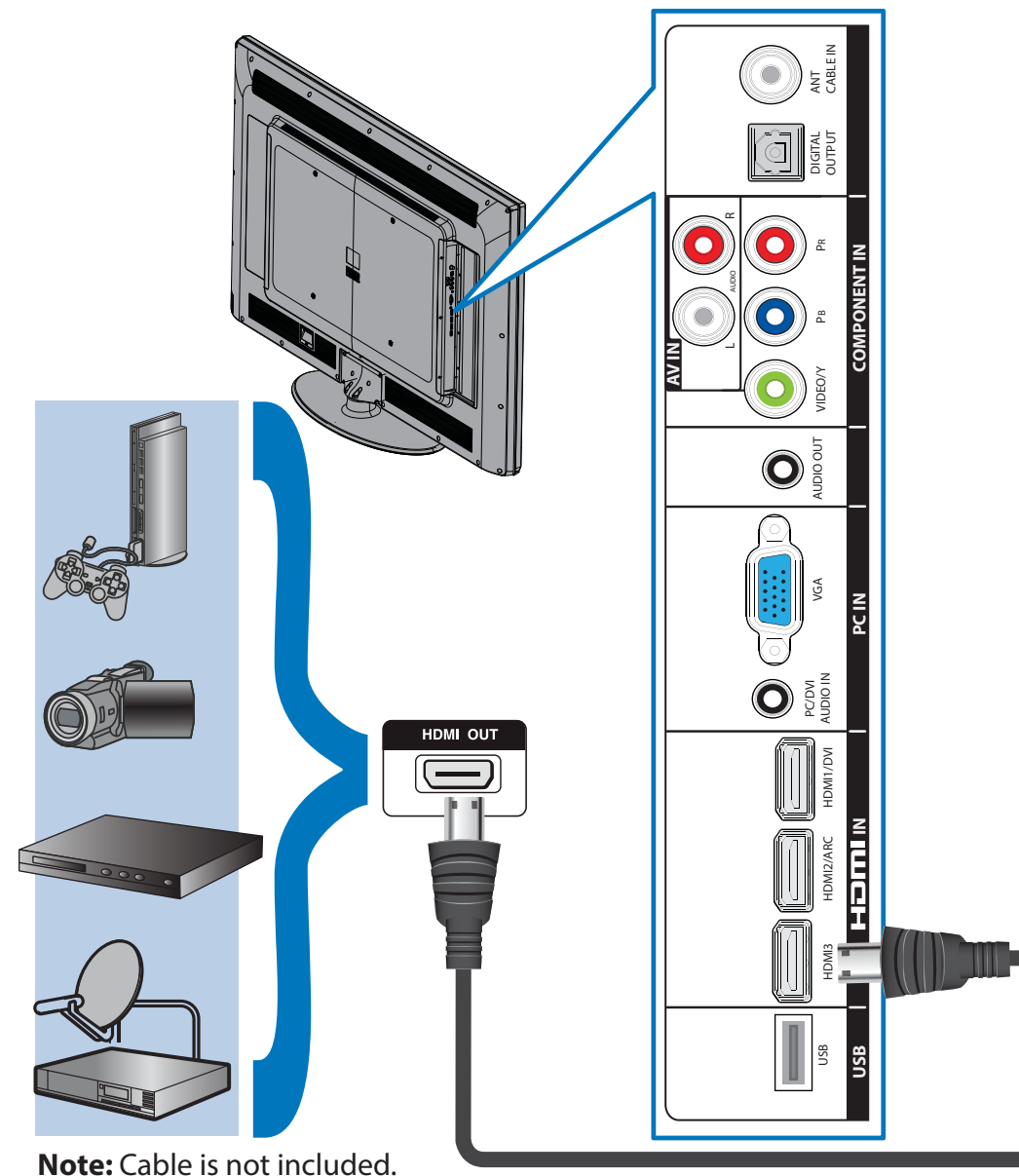

Note: Cable is not included.

Using an AV cable (good)

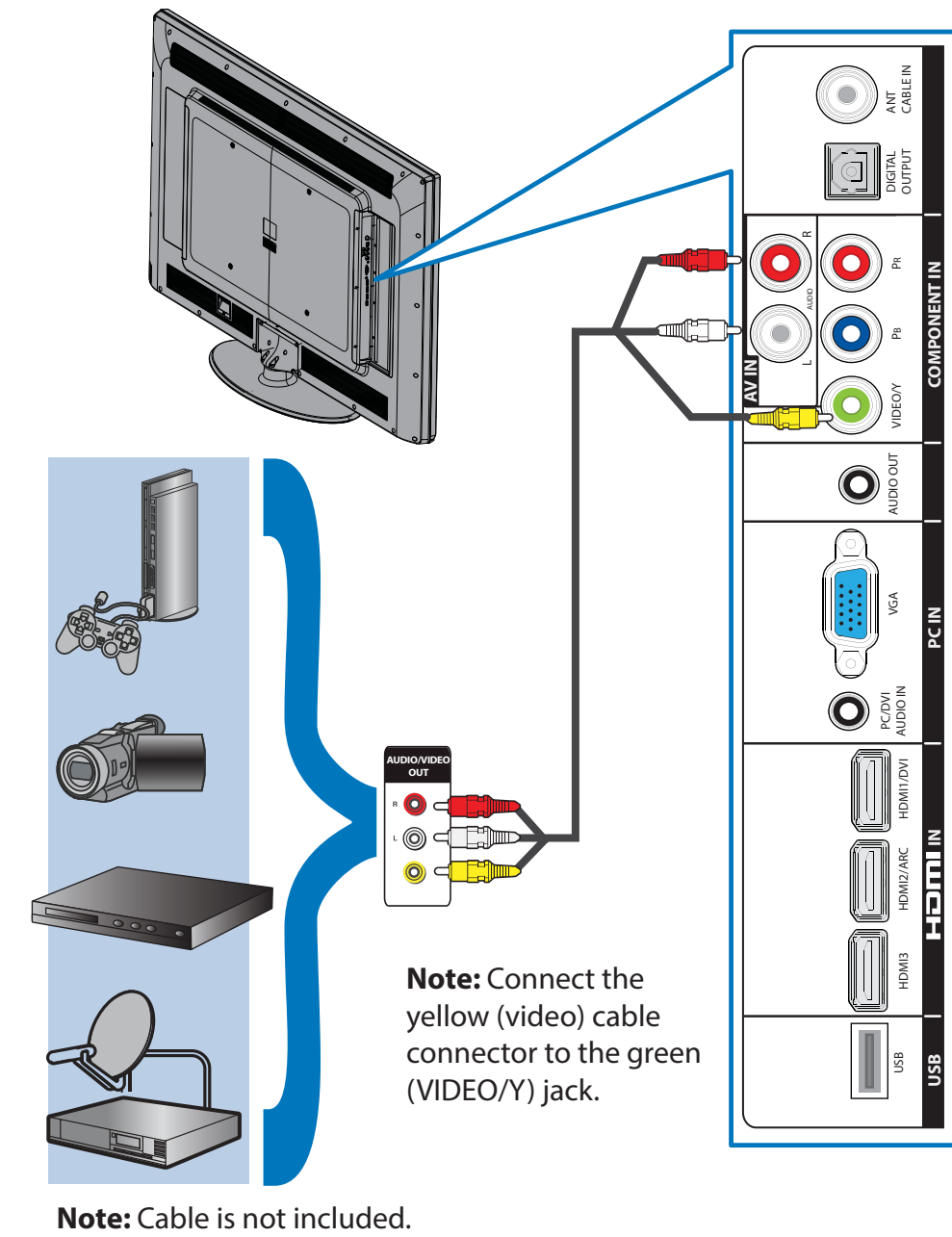

Note: Cable is not included.

Using component cables (better)

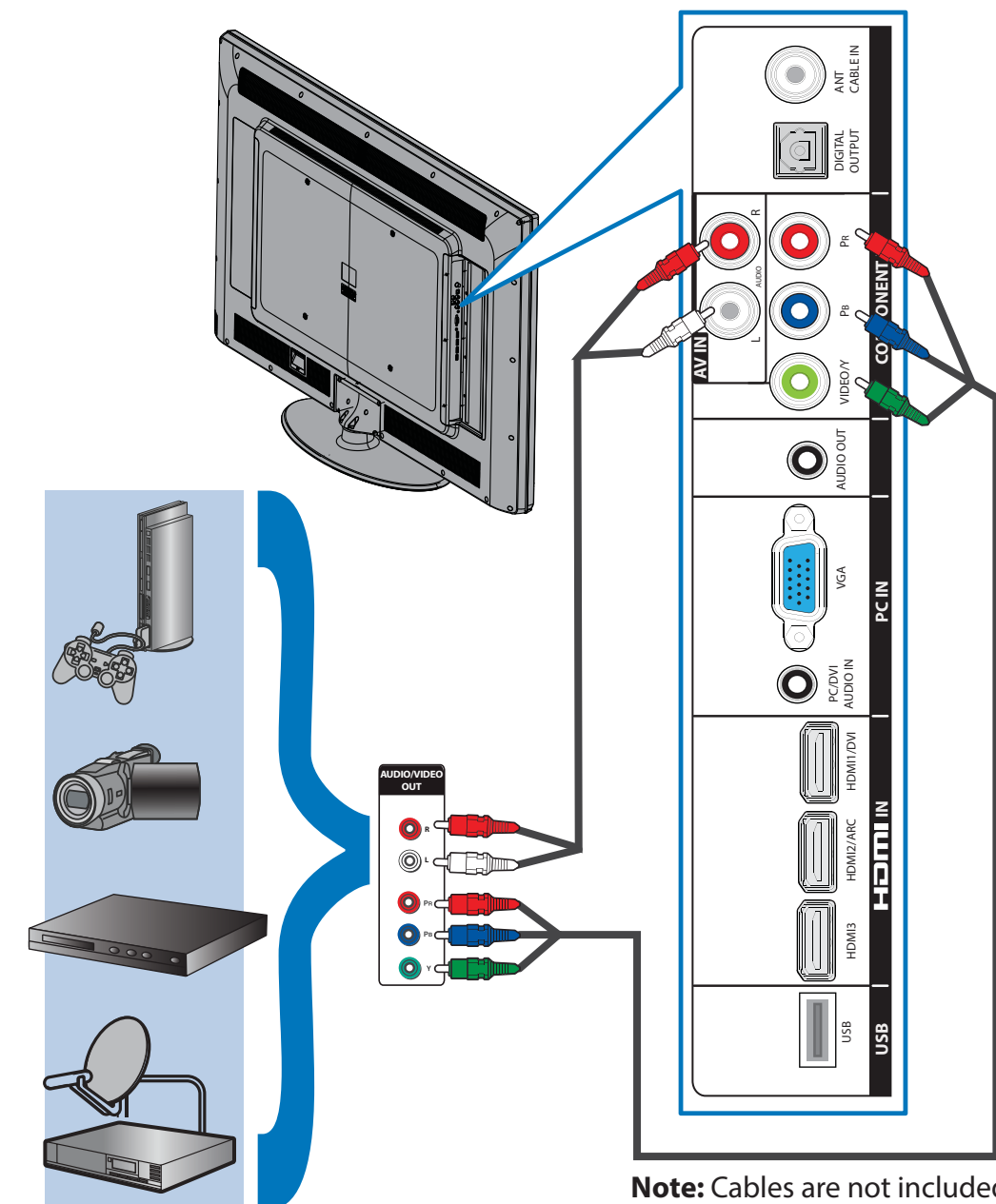

Note: Cables are not included.

Connecting an antenna/cable wall jack

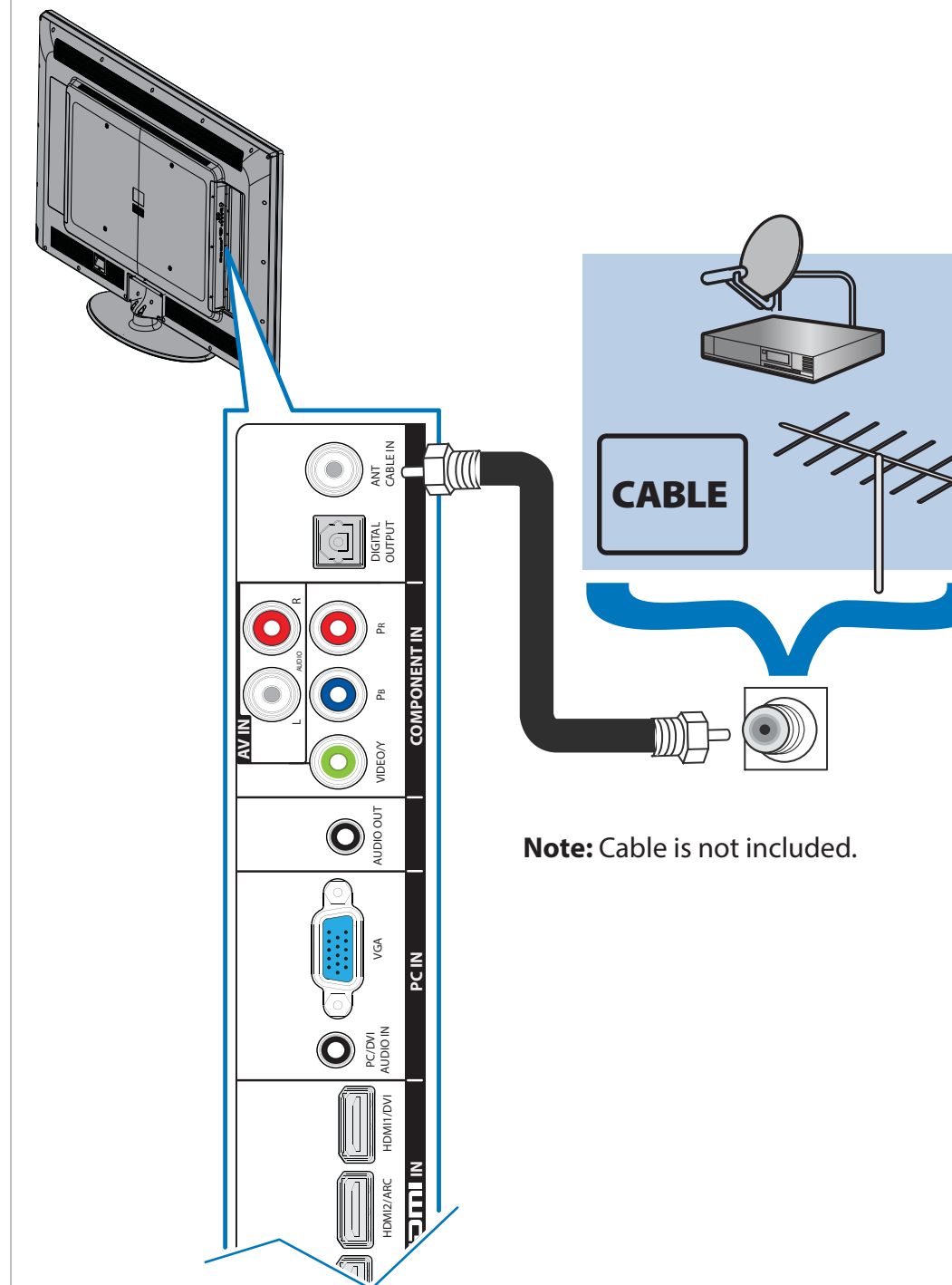

Note: Cable is not included.

Connecting a Home Theater System

Using digital audio

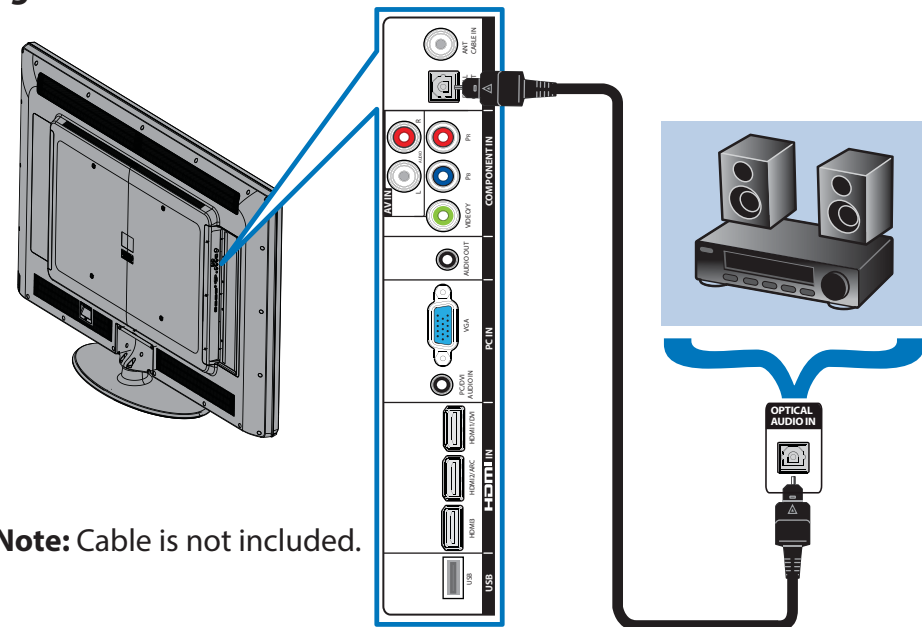

Note: Cable is not included.

Using analog audio

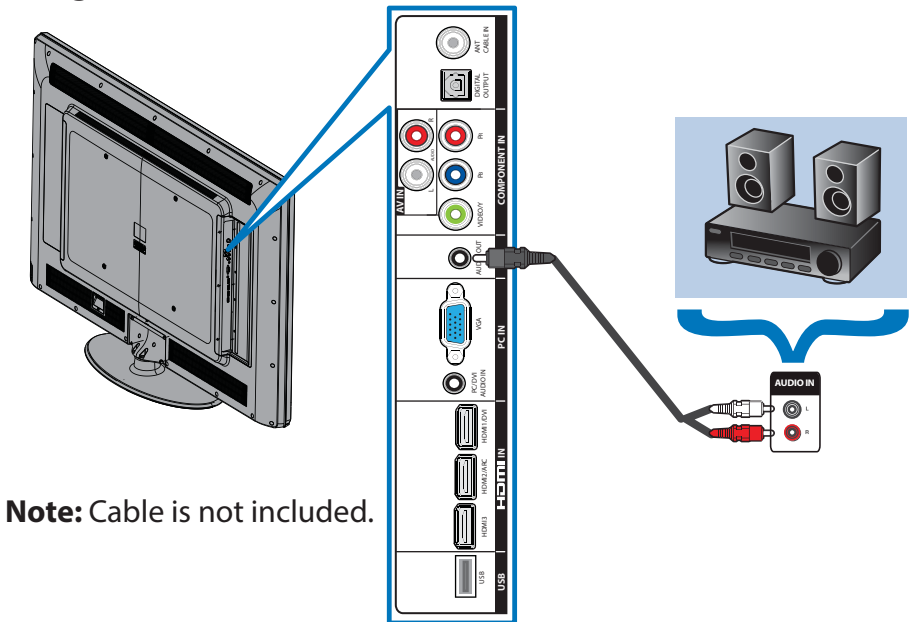

Note: Cable is not included.

Connecting a home theater system with multiple devices

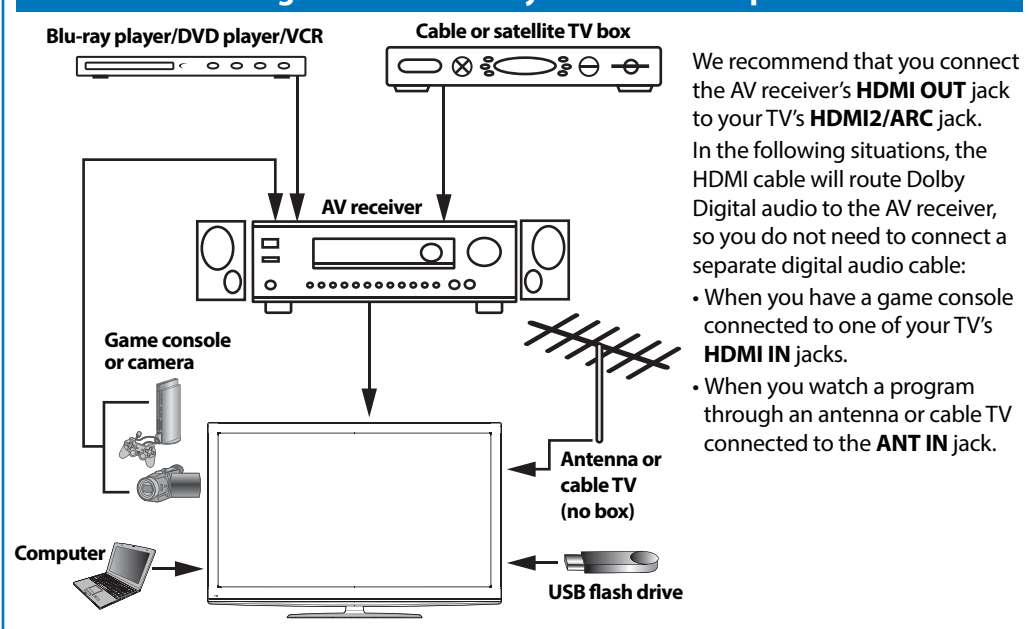

Connecting power

Plug the AC power cord into the **AC IN** jack on the back of your TV, then plug the other end of the cord into a power outlet.

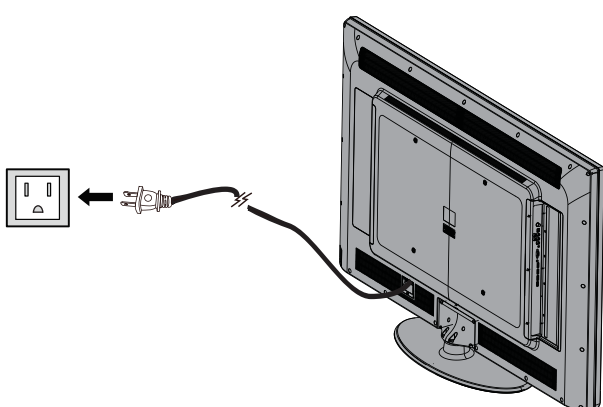

Setting up and using your remote control

- 1 Press the release button on the back of the remote to remove the battery compartment cover.
- 2 Insert two AAA batteries into the battery compartment. Make sure that the + and - symbols on the batteries match the + and - symbols in the battery compartment.
- 3 Replace the cover.

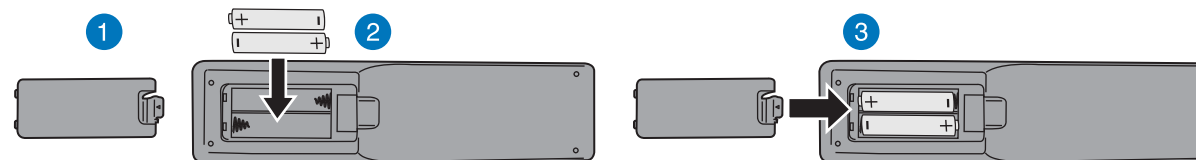

Power
Turns your TV on or off.

Quick Launch Inputs
Select another source connected to your TV.

Numbers
Enter channel numbers.

Enter a digital sub-channel number (e.g. 4.1).

ENTER
Confirms selections or changes.

MENU
Opens the on-screen menu.

EXIT
Closes the on-screen menu.

INPUT
Opens the **INPUT SOURCE** list.

CH-LIST
Opens the channel list.

Volume
Changes the volume.

SLEEP
Sets the sleep timer.

ZOOM
Changes how the picture displays on the screen.

RECALL
Returns to the previous channel.

Arrows
Navigate in on-screen menus.

HOME
Opens the on-screen menu.

INFO*
Opens a TV status banner.

CCD
Turns closed captioning on or off.

FAVORITE
Opens the Favorite Channel list.

MUTE
Mutes the sound.

Channel
Changes the TV channels.

PICTURE
Selects the video mode.

MTS/SAP
Cycles through mono, stereo, and secondary audio for analog programs.

AUDIO
Selects the audio mode.

Inlink Controls
Controls HDMI-CEC devices connected to your TV.

Aspect ratio options

- Normal:** Displays the original 4:3 aspect ratio with vertical black bars on the left and right hand side of the screen.
- Zoom:** Expands the image to fill the screen. The top and bottom of the image may be cropped.
- Wide:** Use this option to view content recorded in a 16:9 (wide-screen) aspect ratio.
- Cinema:** Stretches the image at the edges, but keeps a clear image in the center.
- Auto:** Automatically adjusts the image based on the screen size and the TV program. **Note:** Auto is only available when Auto Zoom in the Channels menu is set to On.

Programming your remote control

To program your universal remote control to work with your new Dynex TV, see the table for common codes. If you have problems programming your remote or need a different remote control code, visit <http://www.dynexproducts.com/remotecodes> for the latest remote control code information.

Universal remote TV codes												
Universal remote controls				Cable/Satellite/Set-top box								
One for All	Philips	RCA	Sony	Cablevision	Charter	Comcast	Cox	DirectTV	Dish Network	Time Warner	TiVo	Verizon
0054	0198, 0490	135	068, 069, 078, 096, 100, 164, 168, 229, 026	068, 069, 078, 096, 100, 164, 168, 229, 026	2002, 1204, 1423, 1517, 0171, 1963, 0463, 1463, 0842, 1326, 167, 415, 424, 450, 456, 461, 507, 523, 567, 577, 586	10171, 11204, 11326, 11463, 11517, 11641, 11780, 11785, 11892, 11963, 12002	1326, 1463	10171, 11204, 11326, 11517, 11564, 11641, 11963, 12002	720	400, 450, 461, 456, 10463, 1463, 0463	0091	0198, 0490

Turning on your TV for the first time

- 1 Connect the power cord to your TV and a power outlet, then press **⏻** (power). The power indicator turns on and the *Choose Your Menu Language* screen opens.
- 2 Press **▲** or **▼** to highlight a language, then press **OK/ENTER**. The *Choose your Time Setting* screen opens with Mode highlighted.
- 3 Press **◀** or **▶** to select **Auto** or **Custom**. If you select **Auto**, the date and time are set automatically from a digital TV signal. If you select **Custom**, you can manually set the date and time. Press **OK/ENTER**. The *Choose your Picture Mode* screen opens.
- 4 Press **▲** or **▼** to highlight **Home Mode** or **Retail Mode**, then press **OK/ENTER**. If you select **Retail Mode**, a message asks you to confirm your selection. Select **Yes** or **No**. Retail Mode is not an energy-saving mode. The *Choose Your TV Source* screen opens.
- 5 Press **▲** or **▼** to highlight **Antenna**, **Cable**, or **Cable/Satellite Box**. If you select **Antenna** or **Cable**, your TV scans for available channels. The scan may take several minutes. **If you select **Cable/Satellite Box**, your TV does not scan for channels.**
- 6 To watch TV, press **TV** on the remote control.



DYNEX

One-year limited warranty

Visit www.dynexproducts.com for details.

Need additional help?

See your *User Guide*! This comprehensive guide includes everything from basic how-to steps to more advanced features. Go to www.dynexproducts.com, then click **Support & Service**. Enter your model number in the **Manual, Firmware, Drivers & Product Information**, then click **Search**.

We're here for you

www.dynexproducts.com
For customer service, call:
800-305-2204 (U.S./Canada markets)

DYNEX is a registered trademark of BBY Solutions, Inc. Registered in some countries. Distributed by Best Buy Purchasing, LLC, 7601 Penn Ave South, Richfield, MN 55423 U.S.A. ©2012 BBY Solutions, Inc. All Rights Reserved.